

TOSHIBA

AIR CONDITIONER (SPLIT TYPE) Owner's Manual



Indoor Unit

Model name:

4-way Air Discharge Cassette Type

RAV-SM564UT-E

RAV-SM804UT-E

RAV-SM1104UT-E

RAV-SM1404UT-E

Not accessible to the general public
Vente interdite au grand public
Kein öffentlicher Zugang
Non accessibile a clienti generici
No destinado al público en general
Não acessível ao público em geral
Niet geschikt voor huishoudelijk gebruik
Μη προσβάσιμο από το γενικό κοινό
Недоступен для посторонних
Genel erişime açık değildir

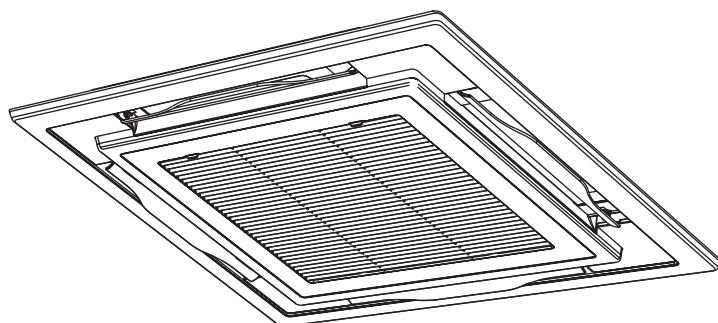

Owner's Manual Air conditioner (Split type)	1	English
Manuel du propriétaire Climatiseur (Type split)	25	Français
Betriebsanleitung Klimagerät (Split-typ)	49	Deutsch
Manuale del proprietario Condizionatore d'aria (Tipo split)	73	Italiano
Manual del propietario Aire acondicionado (Tipo split)	97	Español
Manual do utilizador Ar condicionado (Tipo split)	121	Português
Gebruiksaanwijzing Airconditioner (Gesplitst type)	145	Nederlands
Εγχειρίδιο χρήσης Κλιματιστικό (Τύπου Split)	169	Ελληνικά
Руководство пользователя Кондиционер воздуха (Сплит-система)	193	Русский
Kullanım Kılavuzu Klima (Split tip)	217	Türkçe

Thank you very much for purchasing TOSHIBA Air Conditioner.
 Please read this owner's manual carefully before using your Air Conditioner.

- Be sure to obtain the "Owner's manual" and "Installation manual" from constructor (or dealer).

Request to constructor or dealer

- Please clearly explain the contents of the Owner's manual and hand over it.

ADOPTION OF NEW REFRIGERANT

This Air Conditioner is a new type which adopts a new refrigerant HFC (R410A) instead of the conventional refrigerant R22 in order to prevent destruction of the ozone layer.

Contents

1	PRECAUTIONS FOR SAFETY	2
2	PARTS NAME	4
3	PARTS NAME OF REMOTE CONTROLLER	5
4	CORRECT USAGE	8
5	TIMER OPERATION	10
6	ADJUSTMENT OF WIND DIRECTION	11
7	HOW TO ENABLE POWER SAVING MODE	14
8	SELF CLEANING MODE	14
9	ADVANCED SETTINGS	15
	How to set up swing type	
	How to set up louver lock (No swing)	
	How to set up power saving mode	
10	HINTS FOR ECONOMICAL OPERATION	18
11	MAINTENANCE	19
12	AIR CONDITIONER OPERATIONS AND PERFORMANCE	20
13	INSTALLATION	21
14	TROUBLES AND CAUSES	23

1 PRECAUTIONS FOR SAFETY

WARNING

WARNINGS ABOUT INSTALLATION

- Make sure to ask the qualified installation professional in electric work to install the air conditioner.
If the air conditioner is inappropriately installed by yourself, it may cause water leak, electric shock, fire, and so on.
- Be sure to connect earth wire. (grounding work)
Incomplete grounding causes an electric shock.
Do not connect ground wires to gas pipes, water pipes, lightning rods or ground wires for telephone wires.
- If you install the indoor unit in a small room, take appropriate measures to prevent the refrigerant from exceeding the limit concentration even if it leaks.
Consult the dealer from whom you purchased the air conditioner when you implement the measures. Accumulation of highly-concentrated refrigerant may cause an oxygen deficiency accident.
- Check whether the piping work has been properly completed.
When existing pipes are used and if they are not constructed properly, the refrigerant gas may leak. Contact the installation company and confirm that the piping work has been properly completed. For details of installation of the air conditioner, refer to the Installation Manual. Use tools and piping materials for R410 only. Failure to do so or improper installation may cause a burst of pipe, resulting in injury.



WARNINGS ABOUT OPERATION

- Cleaning of the air filter and other parts of the air filter involves dangerous work in high places, so be sure to have a service person do it.
The self-cleaning function of the air conditioner causes the internal fan to run at a high speed in some modes even while the air conditioner is not working, which may cause injury.
Do not attempt it yourself.
- Avoid cooling the room too strong or exposing the human body to cool breeze for a long time as it is bad for the health.
- When you notice something abnormal with the air conditioner (smells like something scorching, poor cooling, etc.), immediately turn off the main switch, the circuit breaker, from the mains to stop the air conditioner, and contact the dealer.
If the air conditioner is continuously operated with something abnormal, it may cause machine failure, electric shock, fire, and so on.

WARNINGS ABOUT MOVEMENT AND REPAIR

- When the air conditioner cannot cool or heat a room well, contact the dealer from whom you purchased the air conditioner as refrigerant leakage is considered as the cause. In the case of repair that requires refill of refrigerant, ask service personnel about details of the repair.
The refrigerant used in the air conditioner is harmless.
Generally, the refrigerant does not leak. However, if the refrigerant leaks in a room and a heater or stove burner in the room catches fire, it may generate toxic gas.
When you ask service personnel for repairing refrigerant leakage, confirm that the leakage portion has been completely repaired.
- Do not move or repair any unit by yourself.
Since there is high voltage inside the unit, you may get electric shock when removing the cover and main unit.
- Whenever the air conditioner needs repair, make sure to ask the dealer to do it.
If it is repaired imperfectly, it may cause electric shock or fire.
- When moving the air conditioner for re-installing at another place, ask the dealer to do it. If it is imperfectly installed, it may cause electric shock or fire.

⚠ CAUTION

TO DISCONNECT THE APPLIANCE FROM THE MAINS SUPPLY

- This appliance must be connected to the mains by means of a switch with a contact separation of at least **3 mm**.
- **The installation fuse 25A or 16A must be used for the power supply line of this air conditioner.**

CAUTIONS ABOUT INSTALLATION (Be sure to confirm the following cautions.)

- Use an exclusive power circuit for the air conditioner. Use the rated voltage.
- Certainly lay the drain hose for perfect draining.
Bad drainage may cause flooding in the house and getting furniture wet.
- Make sure to connect the air conditioner to an exclusive power supply of the rated voltage, otherwise the unit may break down or cause a fire.
- Do not install the unit in a place where inflammable gas may leak.
If inflammable gas accumulates around the unit, it may cause a fire.

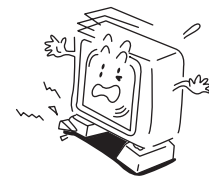

CAUTIONS ABOUT OPERATION

- Carefully read this manual before starting the air conditioner.
There are many important things to keep in mind for daily operation.
- Do not use this air conditioner for special purpose such as preserving food, precision instruments, art objects, breeding animals, car, vessel, etc.
- When the air conditioner is operated with a combustion appliance in the same place, be careful of ventilation to let fresh air enter the room.
Poor ventilation causes oxygen shortage.
- Do not place any combustion appliance in a place where it is directly exposed to the wind of air conditioner, otherwise it may cause imperfect combustion.
- When the air conditioner is used in a closed room, be careful of sufficient ventilation of the room.
Poor ventilation causes oxygen shortage.
- Do not touch any switches with wet finger, otherwise you may get an electric shock.
- If the air conditioner won't be used for a considerably long time, turn off the main switch or the circuit breaker, for safety.
- Do not put anything on the outdoor unit nor step onto it.
If you do so, it may not only topple over the unit but also injure yourself.
- To make the air conditioner operate in its original performance, operate it within the range of the operating temperature specified in the instructions.
Otherwise it may cause a malfunction, or water leak from the unit.
- Prevent any liquid from falling into the remote controller.
Do not spill juice, water or any kind of liquid.

2 PARTS NAME

Indoor unit

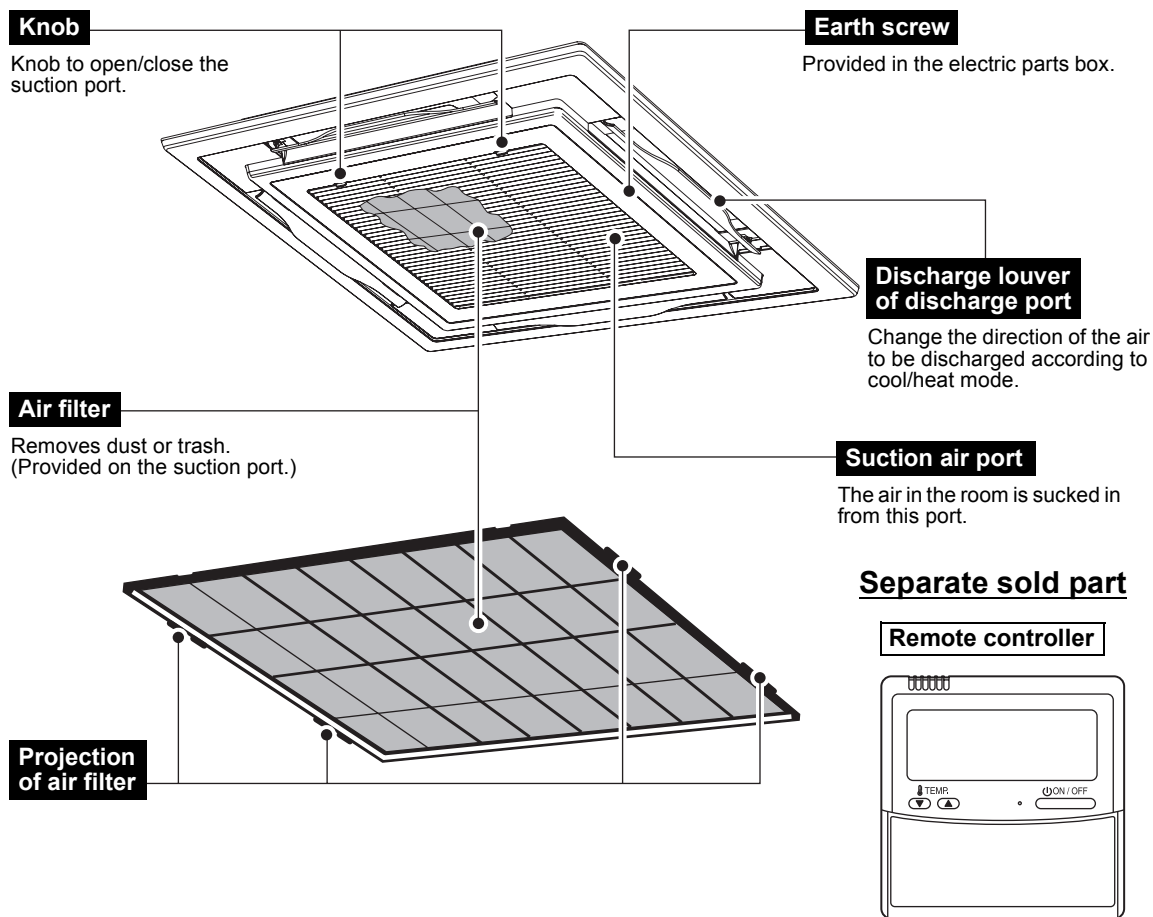

EN

Outdoor unit

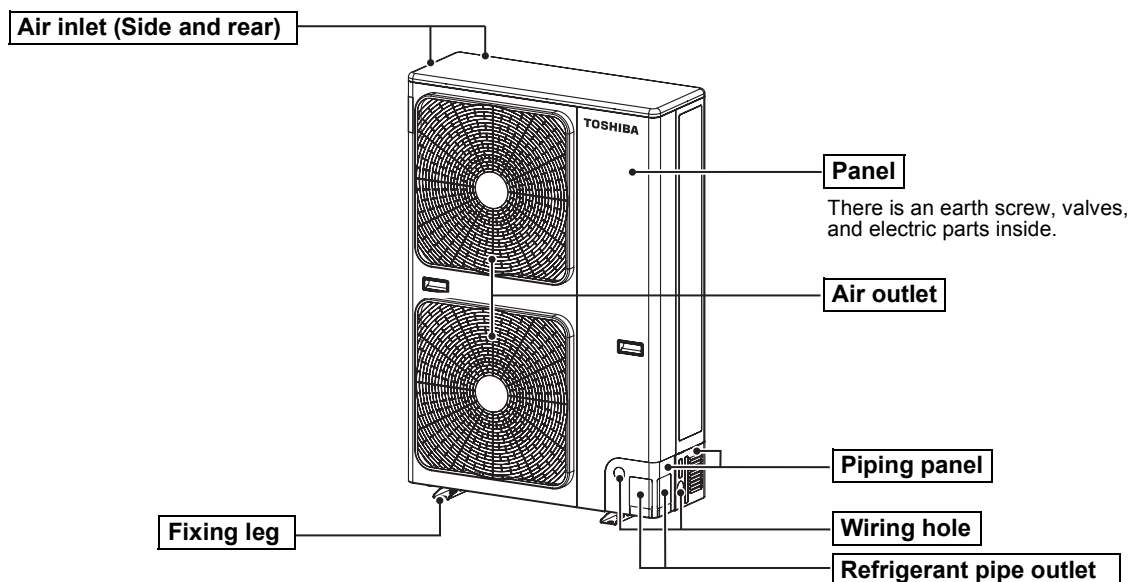

3 PARTS NAME OF REMOTE CONTROLLER

This remote controller can control the operation of up to 8 indoor units.

■ Display section

In the display example, all indicators are displayed for the explanation.

In reality only, the selected contents are indicated.

- When turning on the leak breaker at the first time, **SETTING** flashes on the display part of the remote controller.
- While this display is flashing, the model is being automatically confirmed.

Accordingly, wait for a while after **SETTING** display has disappeared, and then use the remote controller.

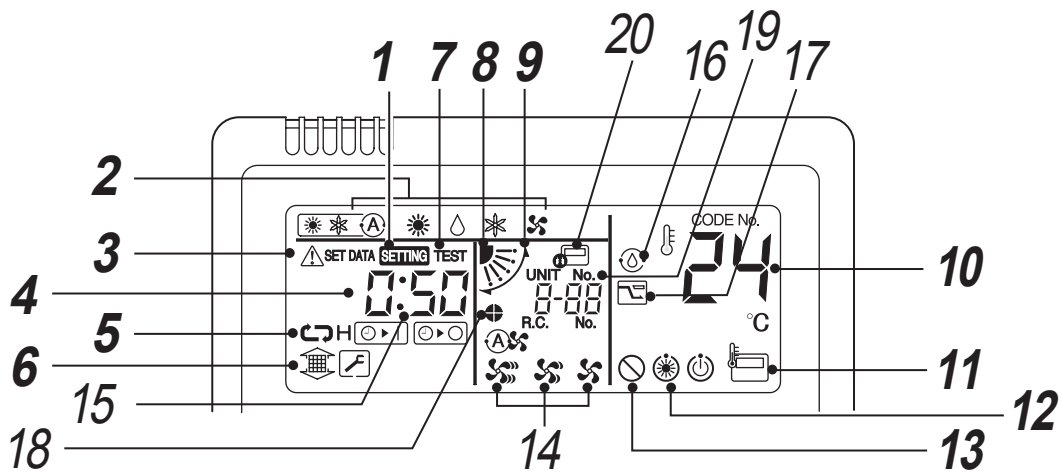
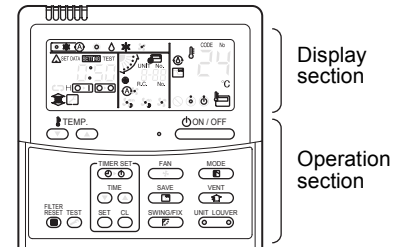



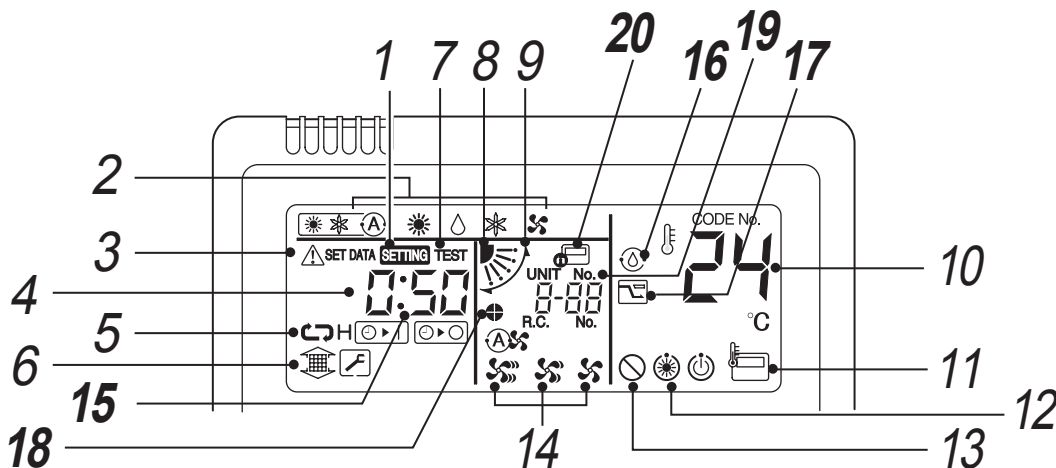

- SETTING display**
Displayed during setup of the timer etc..
- Operation mode select display**
The selected operation mode is displayed.
- CHECK display**
Displayed while the protective device works or a trouble occurs.
- Timer time display**
Time of the timer is displayed.
(When a trouble occurs, the check code is displayed.)
- Timer SET IN setup display**
When pushing the Timer SET IN button, the display of the timer is selected in order of [OFF] [ON] → [OFF] repeat OFF timer → [ON] → No display.
- Filter display**
If "FILTER" is displayed, clean the air filter.
- TEST run display**
Displayed during a test run.
- Louver position display**
Displays louver position.
- SWING display**
Displayed during up/down movement of the louver.
- Set up temperature display**
The selected set up temp. is displayed.
- Remote controller sensor display**
Displayed while the sensor of the remote controller is used.
- PRE-HEAT display**
Displayed when the heating operation starts or defrost operation is carried out.
While this indication is displayed, the indoor fan stops.
- No function display**
Displayed if there is no function even if the button is pushed.



14 Air volume select display

The selected air volume mode is displayed.

- (AUTO) 
- (HIGH) 
- (MED.) 
- (LOW) 

15 Louver Number display.

(example: 01, 02, 03, 04)

16 Dry operation in self cleaning function

Displayed during dry operation in self cleaning function.

17 Power saving mode display

Displayed during capacity saving mode by temporary peak-cut limiting the power current level of the outdoor unit.

18 Louver lock display

Displayed when there is a louver-locked unit in the group (including 1 indoor unit by 1 outdoor unit).

19 Unit Number display

Unit number of the indoor unit selected with the unit select button or abnormal indicate the indoor/outdoor unit.

20 Central control display

Displayed when the air conditioner is used under the central control in combination with a central control remote controller.

In case the remote controller is disabled by the central control system,  flashes. The button operation is not accepted.

Even when you push ON/OFF, MODE, or TEMP. button, and the button operation is not accepted.

(Settings made by the remote controller vary with the central control mode. For details, refer to the Owner's Manual of the central control remote controller.)









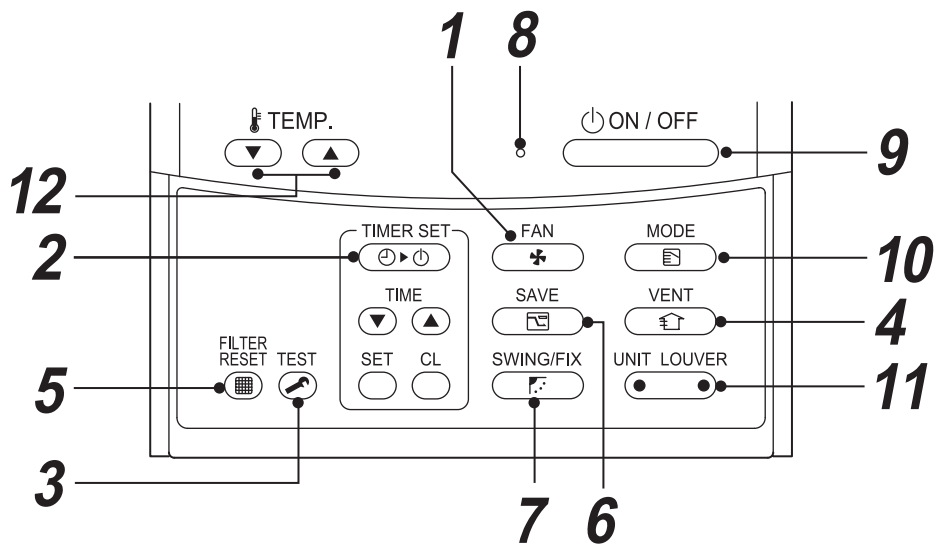







■ Operation section

Push each button to select a desired operation.

- The details of the operation needs to be set up once, afterward, the air conditioner can be used by pushing  button only.



- 1**  **button (Air volume select button)**
Selects the desired air volume mode.
- 2**  **button (Timer set button)**
TIMER SET button is used when the timer is set up.
- 3**  **button (Check button)**
The CHECK button is used for the check operation. During normal operation, do not use this button.
- 4**  **button (Ventilation button)**
Ventilation button is used when a fan which is sold on the market is connected.
 - If “No function  **button (Filter reset button)**
Resets (Erases) “FILTER  **button (Power save operation)**
SAVE button is used for power save operation.
 - 7**  **button (Swing/Wind direction button)**
Selects automatic swing or setting the louver direction.
 - 8** **Operation lamp**
Lamp is lit during the operation. Lamp is off when stopped.
Although it flashes when operating the protection device or abnormal time.
 - 9**  **button**
When the button is pushed, the operation starts, and it stops by pushing the button again. When the operation has stopped, the operation lamp and all the displays disappear.
 - 10**  **button (Operation select button)**
Selects desired operation mode.
 - 11**  **button (Unit/Louver select button)**
Selects a unit number (left) and louver number (right).
UNIT:
Selects an indoor unit when adjusting wind direction when multiple indoor units are controlled with one remote controller.
LOUVER:
Selects a louver when setting louver lock or wind direction adjustment independently.
 - 12**  **button (Set up temperature button)**
Adjusts the room temperature.
Set the desired set temperature by pushing  TEMP.  or  TEMP. .

OPTION :

Remote controller sensor

Usually the TEMP. sensor of the indoor unit senses the temperature. The temperature on the surrounding of the remote controller can also be sensed.

For details, contact the dealer from which you have purchased the air conditioner.

4 CORRECT USAGE

- When you use the air conditioner for the first time or when you change the SET DATA value, follow the procedure below. From the next time, the operation displayed on the remote controller will start by pushing the  button only.

■ Preparation

Turn on the main power switch and/or the leakage breaker.

- When the power supply is turned on, a partition line is displayed on the display part of the remote controller.
- After the power supply is turned on, the remote controller does not accept an operation for approx. 1 minute, but it is not a failure.

REQUIREMENT

- While using the air conditioner, operate it only with  button without turning off the main power switch and the leak breaker.
- When you use the air conditioner after it has not been used for a long period, turn on the leakage breaker at least 12 hours before starting operation.

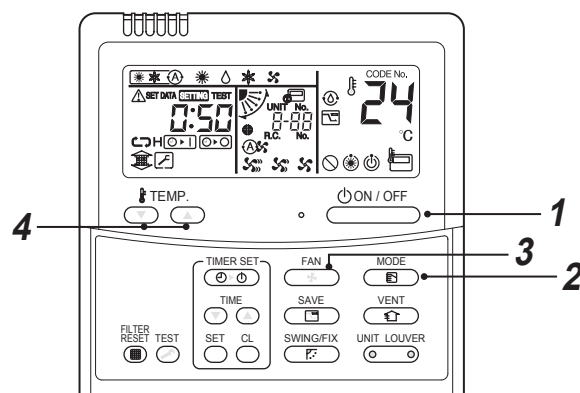

Start

1 Push button.

The operation lamp goes on, and the operation starts.

2 Select an operation mode with the “MODE ” button.



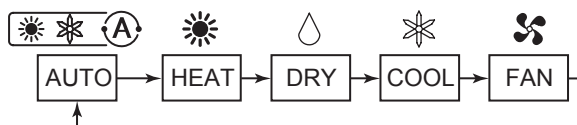

One push of the button, and the display changes in the order shown as follows.

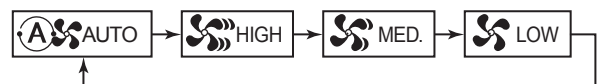

3 Select air volume with “” button.

One push of the button, and the display changes in the order shown as follows.



- When air volume is “ AUTO”, air volume differs according to the room temperature.
- In heating operation, if the room temperature is not heated sufficiently with VOLUME “ LOW” operation, select “ MED.” or “ HIGH” operation.
- The temperature sensor senses temperature near the suction air port of the indoor unit, which differs from the room temperature depending on the installation condition.
A value of setting temperature is the measure of room temperature.
(“AUTO ” is not selectable in the FAN mode.)

4 Determine the set up temperature by pushing the “TEMP. ” or “TEMP. ” button.

Stop

Push  button.

The operation lamp goes off, and the operation stops.

In the COOL, DRY, or AUTO (cooling) mode, the fan runs for 10 minutes (or more) for self cleaning.

In case of automatic operation (Auto Changeover)

- Because of some settings change, it will automatically select either cooling, heating, or fan only operation depending on the indoor temperature.
- If the Auto mode is uncomfortable, you can select the desired conditions manually.

In case of cooling

- Start the cooling operation after approx. 1 minute.

In case of heating

- The heating operation mode is selected in accordance with the room temperature and operation starts after approximately 3 to 5 minutes.
- After the heating operation has stopped, FAN operation may continue for approx. 30 seconds.
- When the room temperature reaches the set temperature and the outdoor unit stops, the super low wind is discharged and the air volume decreases excessively.
During defrost operation, the fan stops so that cool air is not discharged. ("HEAT READY  " is displayed.)
- When the room temperature has reached the set temperature while the outdoor unit is stopping, the indoor unit discharges wind with a very small air volume.

NOTE**When restarting the operation after stop**



- When restarting the operation immediately after stop, the air conditioner does not operate for approx. 3 minutes to protect the machine.

■ 8°C OPERATION (For object pre-heating)

The air conditioner can control the heating temperature to about 8°C in the heating mode.

The 8°C heating operation requires settings with the wired remote controller. Ask the installer or dealer for the settings according to the installation manual of the indoor unit.

Start

1. Set the displayed temperature to 18°C in the heating mode by pushing TEMP.  button.
2. Set the displayed temperature to 8°C by pushing TEMP.  button for at least four seconds.



Stop

1. Set the displayed temperature to 18°C by pushing TEMP.  button.
 - The air conditioner returns to the normal HEAT mode. Select a desired temperature and operation mode.

**CAUTION**

Do not keep the louver position horizontally in the 8°C heating operation, since the heating performance degrades.

NOTE

- The discharged air temperature is lower than that in the normal heating operation.
- The room temperature may not be heated evenly depending on the remote controller installation location.
- The room temperature may not reach 8°C depending on the room size or the installation conditions.
- Settings for air volume and wind direction (swing, etc.) are available during the 8°C heating operation.
The 8°C heating operation is cancelled in the following cases.
 - When operation is stopped with  button
 - When another operation mode is selected with  button
 - When temperature setting or operation mode is changed or operation is started/stopped by the wireless remote controller or the central control remote controller.
- If one or more models other than the 4-way air discharge cassette type (4 series) are connected in the same control group, the 8°C heating operation is not available.

5 TIMER OPERATION

- A type of timer operation can be selected from the following three types. (Setting of up to 168 hours is enabled.)
 OFF timer : The operation stops when the time of timer has reached the set time.
 Repeat OFF timer : Every time, the operation stops after the set time has passed.
 ON timer : The operation starts when the time of timer has reached the set time.

■ Timer operation

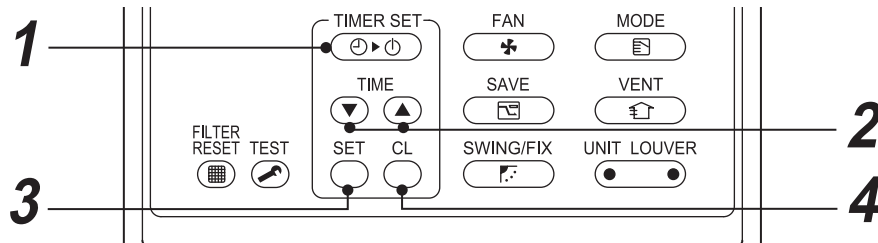

Set

1 Push TIMER SET button.

The timer display (type) changes for every push of the button.

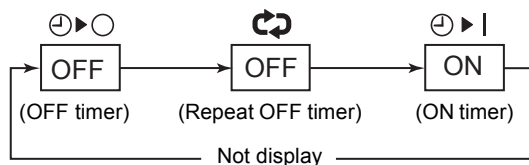

- **SETTING** and timer time displays flash.

2 Push **TIME** to select "SET TIME".

- For every push of **▲** button, the set time increases in the unit of 0.5 hr (30 minutes). When setting a time more than 24 hours for timer operation, timer time can be set in the unit of 1 hr. The maximum set time is 168hr (7 days). The remote controller displays the set time with time (between 0.5 and 23.5 hours) (*1) or number of days and time (24 hours or more) (*2) as shown below.
- For every push of **▼** button, the set time decreases in the unit of 0.5 hr (30 minutes) (0.5 to 23.5 hours) or 1 hr (24 to 168 hours).

Example of remote controller display

- In the case of 23.5 hours (*1)



- In the case of 34 hours (*2)



Number of days Time

1d shows 1 day (24 hours).

10h shows 10 hours. (Total 34 hours)

3 Push SET button.

- **SETTING** display disappears and timer time display goes on, and **▶|** or **▶○** display flashes. (When ON timer is activated, timer time, ON timer **▶|** are displayed and other displays disappear.)

4 Cancel of timer operation

Push **CL** button.

TIMER display disappears.

NOTE

When the operation stops after the timer reached the preset time, the Repeat OFF timer resumes the operation by pushing **ON/OFF** button and stops the operation after the time of the timer has reached the set time.

6 ADJUSTMENT OF WIND DIRECTION

For best cooling and heating performance, adjust the louvers (adjustment plates of up/down wind direction) appropriately. Cold air descends and warm air rises, so to heat a room tilt the louvers downward, and to cool a room tilt them horizontally.



CAUTION

Direct the louvers horizontally for cooling.

If the louvers stay pointed downward when cooling, condensation may form on the discharge port and then drops from the louvers.

NOTE

If the louvers stay pointed straight out horizontally when heating, the room temperature may be unevenly distributed.

For cooling (COOL)

Direct the louvers horizontally.

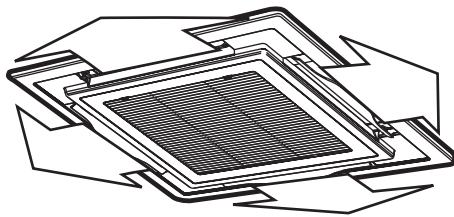

For heating (HEAT)

Direct the louvers downward.

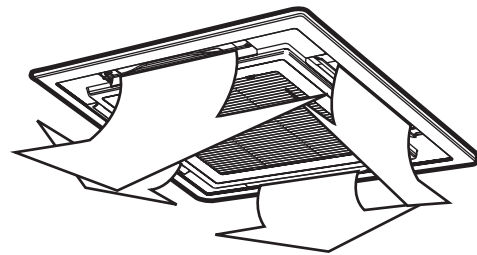

- When the air conditioner is not working, the louvers are directed horizontally automatically.
- The louvers are directed horizontally when heating begins, during defrost operation, or during the minimum operation after reaching the set temperature.
When you make a swing or air direction setting at this time, the remote controller display varies with the setting, but the louvers stay pointed straight out horizontally.
When the air conditioner starts heating, the louvers are directed to the set direction.

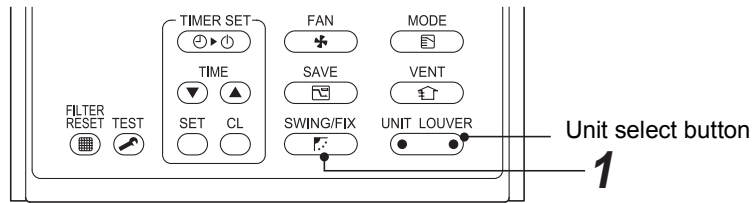

How to set up the wind direction

1 Push during operation. The wind direction changes for every push of the button.

In HEAT operation

Direct the louver (adjustment plate of up/down wind direction) downward. If directing at horizontally, hot air may not come to the foot.

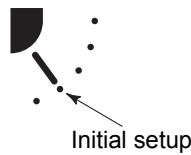

In COOL/DRY operation

Direct the louver (adjustment plate of up/down wind direction) horizontally. If directing it downward, the dew may form on the surface of the air discharge port and may drop down.

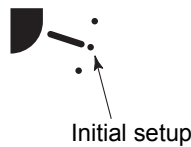

In FAN operation

Select a desired wind direction.

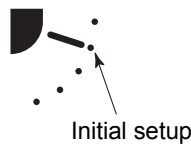

How to start swinging

1 Push , set the louver (adjustment plate of up/down wind direction) direction to the lowest position, and then push again. SWING is displayed and the up/down wind direction is automatically selected.

Display during swinging

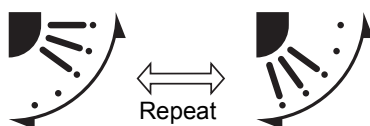

How to stop swinging

1 Push at a desired position while the louver is swinging.

- When is pushed after that, wind direction can be set again from the highest position.
- * However, even if is pushed while the louver is swinging, the louver position is displayed as follows and highest position of the louver may not be selected.

Display when swinging is stopped



In this case, push again two seconds later.

- In COOL/DRY operation, the louver does not stop as it directs downward. If stopping the louver as it directs downward during swing operation, it stops after moving to the third position from the highest position.

Display when stopping the swing



Unit select button

- When multiple indoor units are controlled with one remote controller, wind direction can be set for each indoor unit by selecting in individually.
- To set wind direction individually, push button to display an indoor unit number in the control group. Then set the wind direction of the displayed indoor unit.
- When no indoor unit number is displayed, all indoor units in the control group can be controlled simultaneously.
- Each time you push button, the display changes as follows:

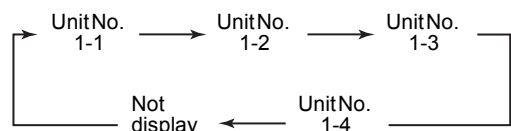

EN

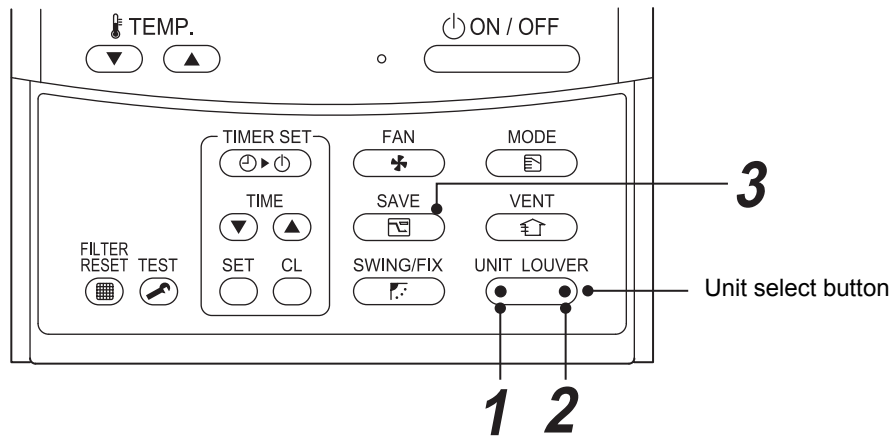

How to set louver wind direction individually

1 Select an indoor unit to be set by pushing  (left side of the button) during operation.

- The indoor unit number changes each time you push the button.

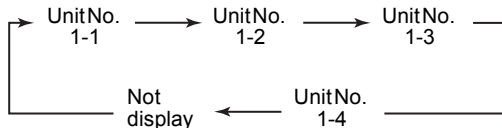

* When no unit number is displayed, all indoor units are selected.

2 Select a louver you want to adjust change by pushing  (right side of the button).

- Each time you push the button, the display on the left of the remote controller changes as follows:



* When no louver number is displayed, all four louvers are selected.

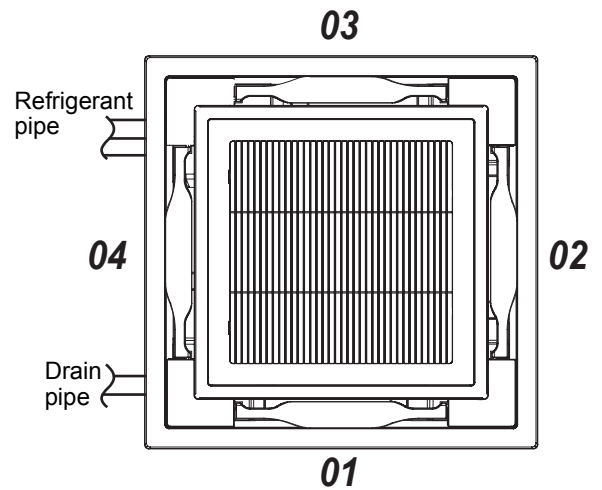
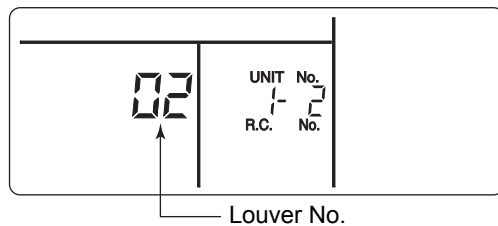

3 Determine wind direction of the selected louver by pushing .

- Each time you push the button, the display changes as follows:

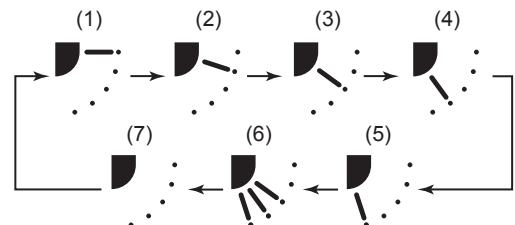

* During COOL (DRY) mode, (4) and (5) are not displayed.

7 HOW TO ENABLE POWER SAVING MODE

Push  button during operation.

- The air conditioner enters power saving mode.
-  appears on the display.

To cancel the power saving operation, push  button again.

-  disappears.

NOTE

- When other electric appliances are used at the same time, to avoid triggering the circuit breaker, power saving mode is recommended. Of course you can use power saving mode to save energy as well.
- Power saving mode consumes less energy, but may not heat/cool the room as much as normal mode. (The maximum current is limited to approximately 75% (factory setting) of the normal mode.)
- To adjust the power-save settings, see "How to set up power saving mode" in ADVANCED SETTINGS.
- Even when operation start/stop, operation mode change, or power reset is performed during the power saving mode, the power saving mode is retained until the next operation.

8 SELF CLEANING MODE

EN

This function is provided to dry the inside of the indoor unit by the FAN operation after running the cooling/dry/AUTO (cooling) mode to keep the indoor unit clean.

- The self cleaning time varies with the cooling/dry/AUTO (cooling) operation time as follows.

Cooling/dry/AUTO (cooling) operation time	self cleaning time
Less than 10 minutes	No self cleaning operation
10 minutes to less than 1 hour	1 hour
More than 1 hour	2 hours

- "⏻" is displayed on the remote controller during self cleaning operation.

To stop self cleaning forcibly, push  button twice in succession.



CAUTION

- The fan continues to run even after  button is pushed to stop operation in some modes. This is normal because the self cleaning mode is in progress.
- The louvers open slightly and are directed horizontally during self cleaning, and they close when the self cleaning is completed.
- The operation lamp (LED) does not light during the self cleaning mode (function).
- The self cleaning mode (function) cannot clean the room or remove the already existing mold and dust inside the indoor unit.
- To cancel the self cleaning function, consult the dealer.

9 ADVANCED SETTINGS

How to set up swing type

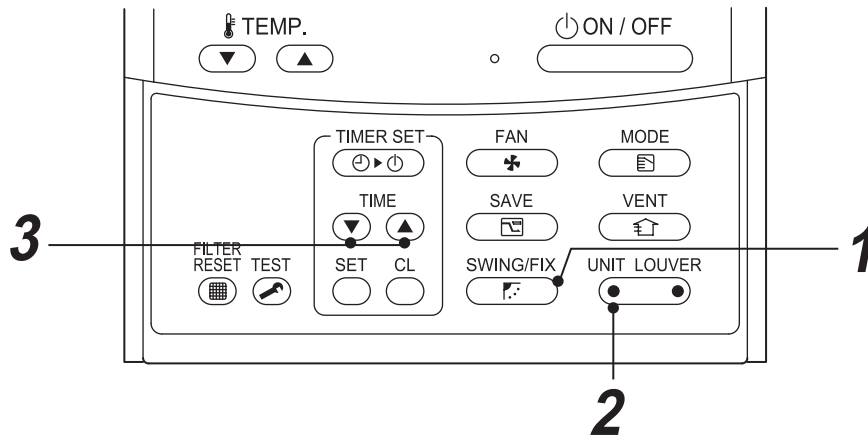

1 Push **SWING/FIX** for at least four seconds when the air conditioner is not working.

- **SETTING**, symbol, and numbers flash.

2 Select an indoor unit to be set by pushing **UNIT LOUVER** (left side of the button).

- Each time you push the button, unit numbers change as follows:

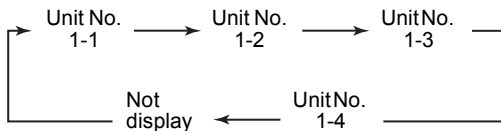

The fan of the selected unit runs and the louvers start swinging.

3 Select a swing type by pushing **TIME** buttons.

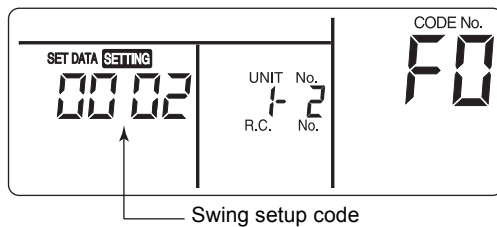

Swing setup code	Swing of louvers
0001	Standard swing (Factory shipping)
0002	Dual swing
0003	Cycle swing

• **Standard swing**

The four louvers swing in the same direction.

• **About "Dual swing"**

"Dual swing" means that louvers **01** and **03** are directed and swing in one direction, and then louvers **02** and **04** are directed and swing in the opposite direction. (When louver **01** is directed downward, louver **02** is directed horizontally.)

• **About "Cycle swing"**

The four louvers swing independently at respective timings.

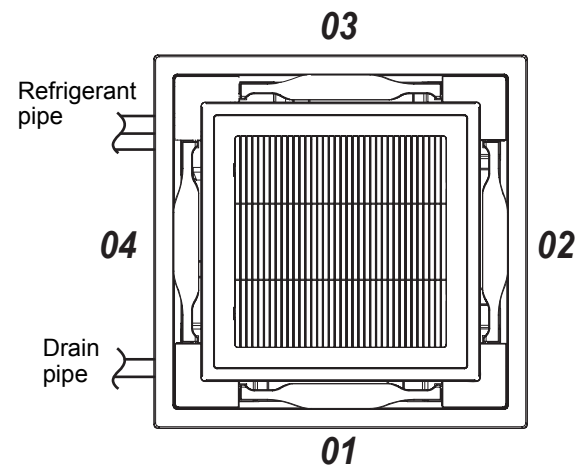

4 Push **SET** button.

5 Push **TEST** button to complete the setting.

CAUTION

- Do not set the swing setup code to "0000". (This setting may cause a failure of the louvers.)

How to set up louver lock (No swing)

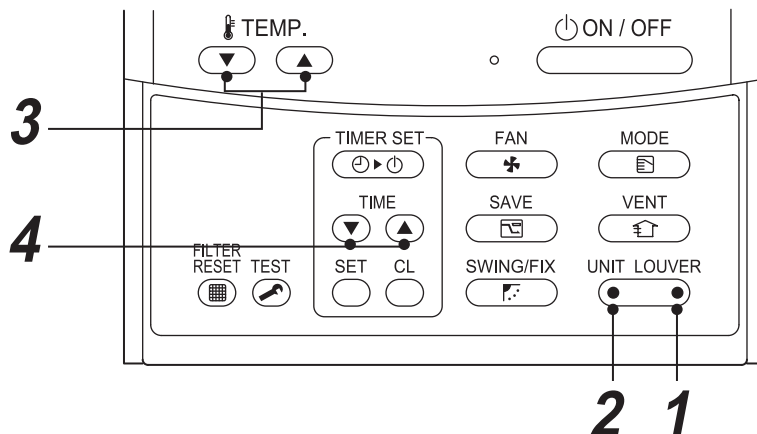

1 Push **UNIT LOUVER** (right side of the button) for at least four seconds when the air conditioner is not working.

- **SETTING**, symbol, and numbers flash.

2 Select an indoor unit to be set by pushing **UNIT LOUVER** (left side of the button).

- Each time you push the button, unit numbers change as follows:
The fan of the selected unit runs and the louvers start swinging.

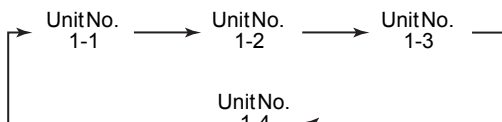

3 Display the number of a louver you want to lock on the temperature display section by pushing **TEMP.** **▼** **▲** buttons.

- The selected louver starts swinging.



4 Select the wind direction of the louver you do not want to swing by pushing **TIME** **▼** **▲** buttons.

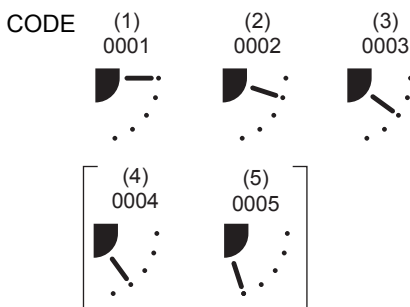

CAUTION

- When (4) or (5) is selected, dew drop may occur during cooling mode.

5 Determine the setting by pushing **SET** button.

- When the setting has been determined, **⊕** lights up.
(To continue louver lock settings for other indoor units, repeat from step 2. To continue louver lock settings for other louvers on the same indoor unit, repeat from step 3.)

6 Push **TEST** button to complete the setting.

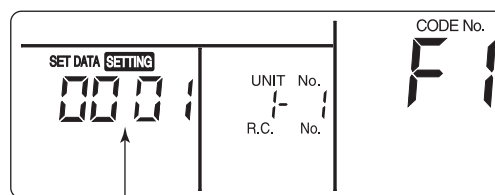

0001-0005
(Louver lock position code)

- A louver number is displayed as **F1**, **F2** on the remote controller (Item Code), showing that louver **01**, **02** shown in the figure on the previous page is selected.

NOTE

Even when louvers are locked, they move temporarily in the following cases:

- While the air conditioner is stopping
- At the beginning of heating operation
- During defrosting operation
- When the room temperature reached the set temperature

How to cancel louver lock

Set the wind direction to "0000" in step 4 of the louver lock setup procedure above.

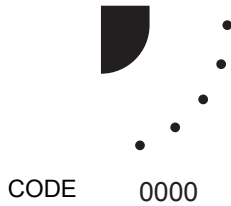

- When the setting is canceled, goes out.
Perform the same operations as steps 1, 2, 3, 5, and 6 above.

How to set up power saving mode

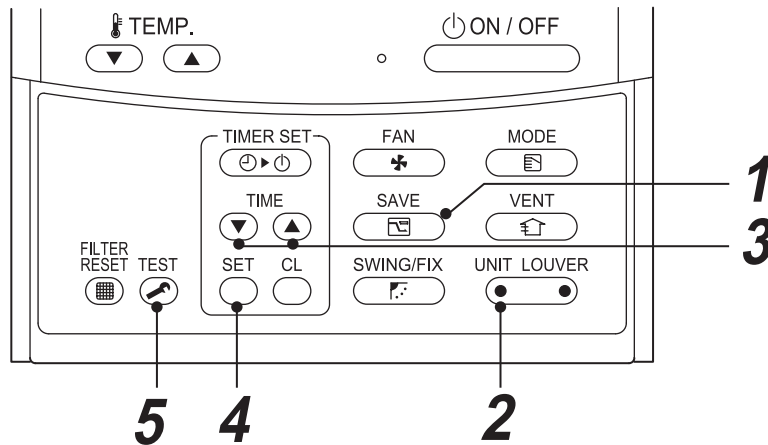

- Push button for at least four seconds when the air conditioner is not working.
 - , symbol, and numbers flash.
- Select an indoor unit to be set by pushing (left side of the button).
 - Each time you push the button, unit numbers change as follows:

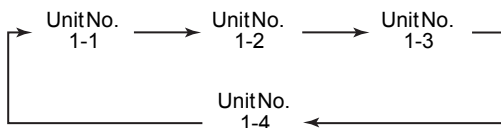

The fan of the selected unit runs and the louvers start swinging.

- Adjust the power-save setting by pushing buttons.
 - Each push of the button changes the power level by 1% within the range from 100% to 50%.
 - * The factory setting is 75%.

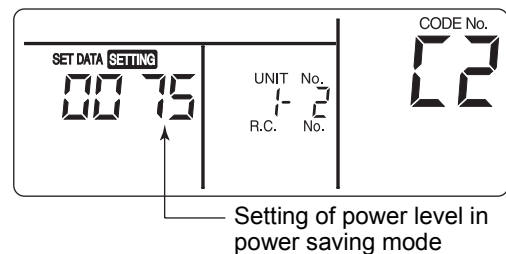

- Push button.
- Push button to complete the setting.

10 HINTS FOR ECONOMICAL OPERATION

Maintain room temperature at comfortable level

Clean air filters

The clogged air filter impairs the performance of the air conditioner.



Never open doors and windows more often than necessary

To keep cool or warm air in the room, never open doors and windows more often than necessary.

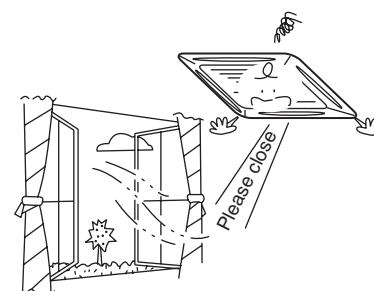

Window curtains

In cooling, close the curtains to avoid direct sunlight.

In heating, close the curtains to keep the heat in.

Get uniform circulation of room air

Adjust the air flow direction for the even circulation of room air.

Checks before operating

- Check whether the ground wires are properly connected.
- Check whether the air filters are installed.
- Turn on the leakage breaker at least 12 hours before operating.

Protective device

- The protective device stops operation when the air conditioner is overloaded.
- When the protective device is activated, the current operation stops and the operation lamp and  on the remote controller flash.

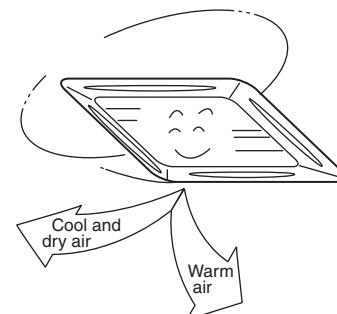

When the protective device is activated

- When the protective device has been activated and stopped operation, turn off the leakage breaker immediately, and ask the installer to find the cause.
If the air conditioner is operated without fixing the problem, the air conditioner may malfunction.
- Check whether the air filters are installed.
If the air filters are not installed, the air heat exchanger may be clogged with dust, which may result in water leakage.

For cooling (COOL)

- When the air inlet and/or outlet of the outdoor unit are blocked
- When the air outlet of the outdoor unit is continuously exposed to strong wind

For heating (HEAT)

- When the air filters are clogged with too much dust or dirt
- When the suction port and/or discharge port of the indoor unit are blocked

Do not turn off the leakage breaker

- Do not turn off the leakage breaker during a test run of the air conditioner. Use the ON/OFF button on the air conditioner instead to control the power.



11 MAINTENANCE

⚠ WARNING

Cleaning of the air filter and other parts of the air filter involves dangerous work in high places, so be sure to have a service person do it. Do not attempt it yourself.

Cleaning of air filters

Clogging of air filters will reduce the cooling and heating performance.

- (1) When "FILTER 
- (2) When the cleaning of air filters has been completed, push  button. "FILTER 

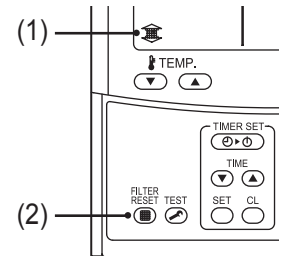

⚠ CAUTION

Cleaning of unit

Clean the unit with a soft dry cloth.

If dirt cannot be removed with the dry cloth, use a cloth slightly dampened with lukewarm (under 40 °C) water.

Cleaning of remote controller

- Use a dry cloth to wipe the remote controller.
- A cloth dampened with cold water may be used on the indoor unit if it is very dirty.
- Never use a damp cloth on the remote controller.
- Do not use a chemically-treated duster for wiping or leave such materials on the unit for long. It may damage or fade the surface of the unit.
- Do not use benzine, thinner, polishing powder, or similar solvents for cleaning. These may cause the plastic surface to crack or deform.

Periodic check

Long-period use of the air conditioner may cause deterioration or failure of parts due to heat, humidity, dust, and operating conditions, or may cause poor drainage of dehumidified water.

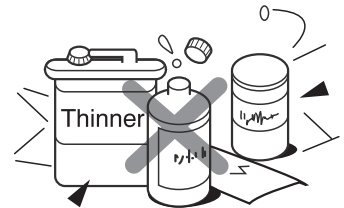

If you do not plan to use the unit for more than 1 month

- (1) In addition to the self cleaning, operate the fan for 1 or 2 hours to dry inside the unit.
 - Operate "FAN" mode.
- (2) Stop the air conditioner and turn off the main power switch or the circuit breaker.



Checks before operation

- (1) Check that the air filters are installed.
- (2) Check that the air outlet or inlet is not blocked.
- (3) Turn on the main power switch or the circuit breaker for the main power supply to the air conditioner.



NOTE

- For Air conditioning system which is operated regularly, cleaning and maintenance of the indoor/outdoor units are strongly recommended. As a general rule, if an indoor unit is operated for about 8 hours daily, the indoor/outdoor units will need to be cleaned at least once every 3-month. This cleaning and maintenance shall be carried out by a qualified person. Failure to clean the indoor/outdoor units regularly will result in poor performance, freezing, water leaking and even compressor failure.

12 AIR CONDITIONER OPERATIONS AND PERFORMANCE

3 minutes protection function

3-minutes protection function prevents the air conditioner from starting for initial 3 minutes after the main power switch/circuit breaker is turned on for re-starting the air conditioner.

Power failure

Power failure during operation will stop the unit completely.

- To restart the operation, push the START/STOP button on the remote controller.
- Lightning or a wireless car telephone operating nearby may cause the unit to malfunction. Turn off the main power switch or circuit breaker and then turn them on again. Push the START/STOP button on the remote controller to restart.

Heating characteristics

Preheating operation

The air conditioner will not deliver warm air immediately after it is turned on. Warm air will start to flow out after approximately 5 minutes when the indoor heat exchanger warmed up.

Warm air control (In heating operation)

When the room temperature reaches the set temperature, the fan speed is automatically reduced to prevent to blow cold draft. At this time, the outdoor unit will stop.

Defrosting operation

If the outdoor unit is frosted during the heating operation, defrosting starts automatically (for approximately 2 to 10 minutes) to maintain the heating capacity.

- The fans in both indoor and outdoor units will stop during the defrosting operation.
- During the defrosting operation, the defrosted water will be drained from the bottom plate of the outdoor unit.

Heating capacity

In the heating operation, the heat is absorbed from the outside and brought into the room. This way of heating is called heat pump system. When the outside temperature is too low, it is recommended to use another heating apparatus in combination with the air conditioner.

Attention to snowfall and freeze on the outdoor unit

- In snowy areas, the air inlet and air outlet of the outdoor unit are often covered with snow or frozen up. If snow or freeze on the outdoor unit is left as it is, it may cause machine failure or poor warming.
- In cold areas, pay attention to the drain hose so that it perfectly drains water without water remaining inside for freeze prevention. If water freezes in the drain hose or inside the outdoor unit, it may cause machine failure or poor warming.

Air conditioner operating conditions

For proper performance, operate the air conditioner under the following temperature conditions:

Cooling operation	Outdoor temperature : -15°C to 43°C
	Room temperature : 21°C to 32°C (Dry valve temp.), 15°C to 24°C (Wet valve temp.)
	[CAUTION] Room relative humidity – less than 80 %. If the air conditioner operates in excess of this figure, the surface of the air conditioner may cause dewing.
Dry operation	Outdoor temperature : 15°C to 43°C
	Room temperature : 17°C to 32°C
Heating operation	Outdoor temperature : -15°C to 15°C (Wet valve temp.)
	Room temperature : 15°C to 28°C (Dry valve temp.)

If air conditioner is used outside of the above conditions, safety protection may work.

13 INSTALLATION

Installation place

CAUTION

- **Check that the air conditioner is not installed in a place subject to combustible gas leak.**
Accumulation of combustible gas around the unit may cause a fire.
- Drain the dehumidified water from the indoor unit and outdoor unit to a well-drained place.
- Do not put any obstacle near the air inlets and air outlet of the outdoor unit. Doing so may hinder the radiation, which may reduce the performance or activate the protective device.

Electrical wiring

WARNING

- Be sure to connect earth wire. (grounding work)
Incomplete grounding cause an electric shock.
Do not connect ground wires to gas pipes, water pipes, lightning rods or ground wires for telephone wires.

CAUTION

- **Make sure that a leakage breaker is connected.**
Using the air conditioner without leakage breaker may cause electric shock.
- **Use a leakage breaker with an appropriate capacity.**
Be sure to use the rated voltage and an exclusive circuit for power supply of the air conditioner.

Do not install the air conditioner in the following places

- Do not install the air conditioner in any place within 1 m from a TV, stereo, or radio set. If the unit is installed in such place, noise transmitted from the air conditioner affects the operation of these appliances.
- Do not install the air conditioner near a high frequency appliance (sewing machine or massager for business use, etc.), otherwise the air conditioner may malfunction.
- Do not install the air conditioner in a humid or oily place, or in a place where steam, soot, or corrosive gas is generated.
- Do not install the air conditioner in a salty place such as seaside area.
- Do not install the air conditioner in a place where a great deal of machine oil is used.
- Do not install the air conditioner in a place where it is usually exposed to strong wind such as in seaside area.
- Do not install the air conditioner in a place where sulfurous gas generated such as in a spa.
- Do not install the air conditioner in a vessel or mobile crane.
- Do not install the air conditioner in an acidic or alkaline atmosphere (in a hot-spring area or near a chemicals factory, or in a place subject to combustion emissions). Corrosion may be generated on the aluminum fin and copper pipe of the heat exchanger.
- Do not install the air conditioner near an obstacle (air vent, lighting equipment, etc.) that disturbs discharge air. (Turbulent airflow may reduce the performance or disable devices.)
- Do not use the air conditioner for special purposes such as preserving food, precision instruments, or art objects, or where breeding animals or growing plants are kept. (This may degrade the quality of preserved materials.)
- Do not install the air conditioner over an object that must not get wet. (Condensation may drop from the indoor unit at a humidity of 80% or more or when the drain port is clogged.)
- Do not install the air conditioner in a place where an organic solvent is used.
- Do not install the air conditioner near a door or window subject to humid outside air. Condensation may form on the air conditioner.
- Do not install the air conditioner in a place where special spray is used frequently.

Be careful with noise or vibrations

- Do not install the air conditioner in a place where noise by outdoor unit or hot air from its air outlet annoys your neighbors.
- Install the air conditioner on a solid and stable foundation so that it prevents transmission of resonating, operation noise and vibration.
- If one indoor unit is operating, some sound may be audible from other indoor units that are not operating.

 **WARNING**

Re-Installation

Ask the dealer or an installation professional to re-install the air conditioner to a new place or move it to another place and to observe the following items.

If the air conditioner is inappropriately installed by yourself, it may cause electric shock or fire.

Maintenance

- For Air conditioning system which is operated regularly, cleaning and maintenance of the indoor/outdoor units are strongly recommended.
As a general rule, if an indoor unit is operated for about 8 hours daily, the indoor/outdoor units will need to be cleaned at least once every 3-month. This cleaning and maintenance shall be carried out by a qualified person.
Failure to clean the indoor/outdoor units regularly will result in poor performance, freezing, water leaking and even compressor failure.
- This product incorporates a drain pump.
If it is used in a place full of dust or oil mist, the pump will be clogged and proper drainage is disabled. Clean the drain pump periodically. For how to clean the drain pump, contact the dealer.

 **CAUTION**

Be sure to clean the heat exchanger with pressurized water.

If an commercially detergent (strong alkaline or acid cleaning agent) is used, the surface treatment of the heat exchanger will be marred, which may degrade the self cleaning performance.

For details, contact the dealer.

14 TROUBLES AND CAUSES

⚠ CAUTION

If any of the following conditions occur, turn off the main power supply switch and immediately contact the dealer :

- Switch operation does not work properly.
- The main power fuse often blows out, or the circuit breaker is often activated.
- A foreign matter or water fall inside the air conditioner.
- When the air conditioner does not operate even after the cause of the protective device activation has been removed. (The operation lamp and  on the remote controller are flashing.)
- Any other unusual conditions are observed.

Before you ask for servicing or repairs, check the following points.

▼ Recheck Inoperative

- The main power switch is turned off.
- The circuit breaker is activated to cut off power supply.
- The main power fuse has blown out.
- The louvers are not directed correctly.

Does not cool well or heat well

- The air inlet and/or outlet of the outdoor unit is blocked.
- Doors or windows are opened.
- The fan speed is set to low.
- The air conditioner is set in the DRY mode in cooling.
- The set temperature is too high (In cooling) or low (In heating).

▼ These are not failures.

Indoor unit or outdoor unit makes a strange noise.

- When the temperature suddenly changes, the indoor or outdoor unit occasionally makes a strange noise because of expansion/ contraction of parts or change of refrigerant flow.
- A “busyu” sound is heard occasionally.
It is generated by the solenoid valve when it is actuated.
- A clattering sound is heard when the power is turned on.
It is generated by the outdoor unit during preparation for operation.

The room air is smelly or a bad odor comes from the air conditioner.

- Smells impregnated in the walls, carpets, furniture, clothing, or furs, come out.

Outdoor unit is frosted in heating operation.

Water drains from outdoor unit.

- The outdoor unit is sometimes frosted in heating operation.
In that case, the unit automatically performs defrosting (for 2 to 10 minutes) for increasing the heating efficiency.
- In defrosting operation, both the indoor and outdoor units stop air flow.
- Hiss sound is heard when flow of the refrigerant is changed for defrosting.
- Resultant water of automatic defrosting in heating operation drains from outdoor unit.

The fan does not stop when the operation is stopped.

- The fan runs in the self cleaning mode to dry the heat exchanger.

Air flow changes though the FAN button is not set to the AUTO mode.

- When the temperature of blown air drops in heating operation, the air conditioner automatically changes or stops air flow from the indoor unit not to make persons in the room feel chilly.
- Air flow from the indoor unit is occasionally changed in the cooling operation.

A white mist of chilled air or water is generated from the outdoor unit.

- When the indoor unit in cooling operation or the outdoor unit in defrosting operation occasionally steams.

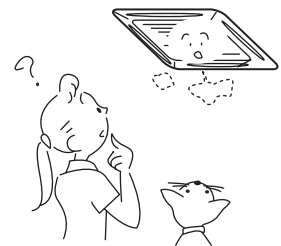

Check these items. If any of these problems still remains, stop the operation, turn off the leakage breaker, and then notifies the dealer of the serial number and details of the error. Never repair any part by yourself as it is dangerous. When  and a combination of **E**, **F**, **H**, **L**, or **P** and a number are displayed on the remote controller, also inform the dealer of the display content.

TOSHIBA CARRIER CORPORATION
23-17, TAKANAWA 3-CHOME, MINATOKU, TOKYO 108-0074, JAPAN

EH99930901